

■ PRODUCT CHARACTERISTICS

V_{DSS}	650V
$R_{DS(ON)}$ Typ(@ $V_{GS}=10V$)	0.67 Ω
Qg@typ	29nC
I_D	10A

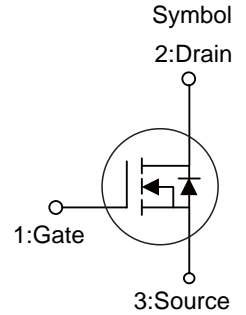

■ APPLICATIONS

- * High efficiency switch mode power supplies
- * Electronic lamp ballasts based on half bridge
- * LED power supplies

■ FEATURE

- * High Switching Speed
- * Improved dv/dt capability

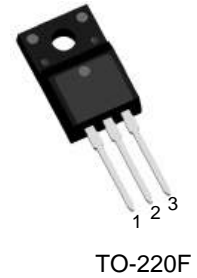

■ ORDER INFORMATION

Order Codes		Package	Packing
Halogen-Free	Halogen		
N/A	MOT10N65F	TO-220F	50 pieces/Tube

■ ABSOLUTE MAXIMUM RATINGS($T_A=25^{\circ}C$, unless otherwise specified)

Parameter	Symbol	Ratings	Unit
Drain-Source Voltage	V_{DSS}	650	V
Gate-Source Voltage	V_{GSS}	± 30	V
Drain Current Continuous(@ $V_{GS}=10V, T_A=25^{\circ}C$)	I_D	10	A
Drain Current Pulsed	I_{DM}	40	A
Avalanche Energy *	E_{AS}	760	mJ
Peak Diode Recovery dv/dt	dv/dt	5.0	V/ns
Power Dissipation	P_D	40	W
Junction Temperature	T_J	+150	$^{\circ}C$
Storage Temperature	T_{STG}	-55~ +150	$^{\circ}C$

■ THERMAL CHARACTERISTICS

Parameter	Symbol	Typ	Unit
Junction to Ambient	R_{thJA}	62.5	$^{\circ}C/W$
Junction to Case	R_{thJC}	3.13	$^{\circ}C/W$

Note: * EAS condition: $T_J=25^{\circ}C, V_{DD}=50V, V_G=10V, L=10mH, R_g=25\Omega$

■ ELECTRICAL CHARACTERISTICS ($T_C=25^{\circ}\text{C}$, unless otherwise noted)

Parameter	Symbol	Test Conditions	Min	Typ	Max	Unit
Off characteristics						
Drain to Source Breakdown Voltage	V_{DSS}	$V_{GS}=0V, I_D=250\mu A$	650	-	-	V
Drain to Source Leakage Current	I_{DSS}	$V_{DS}=650V, V_{GS}=0V$	-	-	1	μA
Gate to Source Forward Leakage	$I_{GSS(F)}$	$V_{DS}=0V, V_{GS}=+30V$	-	-	100	nA
Gate to Source Reverse Leakage	$I_{GSS(R)}$	$V_{DS}=0V, V_{GS}=-30V$	-	-	-100	nA
On characteristics						
Drain to Source On-Resistance	$R_{DS(ON)}$	$V_{GS}=10V, I_D=5A$	-	0.67	0.75	Ω
Gate Threshold Voltage	$V_{GS(TH)}$	$V_{DS}=V_{GS}, I_D=250\mu A$	2	-	4	V
Dynamic characteristics						
Gate capacitance	R_g	$V_{GS}=0V, V_{DS}=0V, f=1.0\text{MHz}$	-	2.5	-	Ω
Forward Transconductance	g_{fs}	$V_{DS}=10V, I_D=3A$	-	8	-	S
Input Capacitance	C_{iss}	$V_{DS}=25V, V_{GS}=0V$ $f=1.0\text{MHz}$	-	1700	-	pF
Output Capacitance	C_{oss}		-	124	-	pF
Reverse Transfer Capacitance	C_{rss}		-	3.3	-	pF
Resistive Switching Characteristics						
Turn-on Delay Time	$t_{d(ON)}$	$I_D=10A, V_{DS}=325V$ $R_G=10\Omega, V_{GS}=10V$	-	27	-	ns
Rise Time	t_r		-	22	-	ns
Turn-off Delay Time	$t_{d(OFF)}$		-	53	-	ns
Fall Time	t_f		-	24	-	ns
Total Gate Charge	Q_g	$I_D=10A, V_{DS}=325V$ $V_{GS}=10V$	-	29	-	nC
Gate to Source Charge	Q_{gs}		-	8	-	nC
Gate to Drain("Miller") Charge	Q_{gd}		-	12	-	nC
Source-Drain Diode Characteristics						
Continuous Source Current(Body Diode)	I_S		-	-	10	A
Maximum Pulsed Current(Body Diode)	I_{SM}		-	-	40	A
Diode Forward Voltage	V_{SD}	$I_{SD}=1A, V_{GS}=0V$	-	0.7	1.2	V
Reverse Recovery Time	t_{rr}	$I_{SD}=10A, T_J=25^{\circ}\text{C}$	-	528	-	ns
Reverse Recovery Charge	Q_{rr}	$di/dt=100A/\mu s$	-	3220	-	nC

■ TYPICAL CHARACTERISTICS

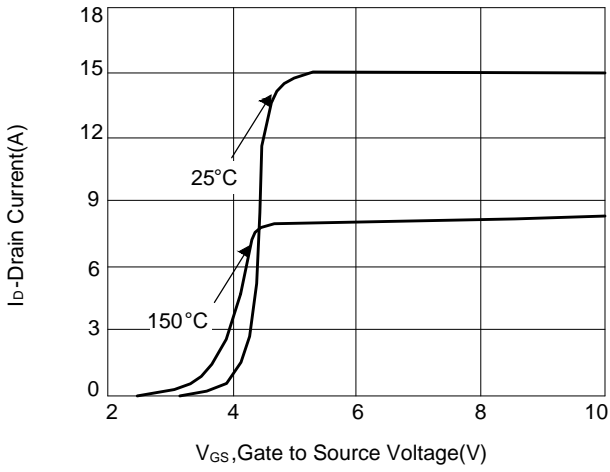

Figure 1: Transfer Characteristics

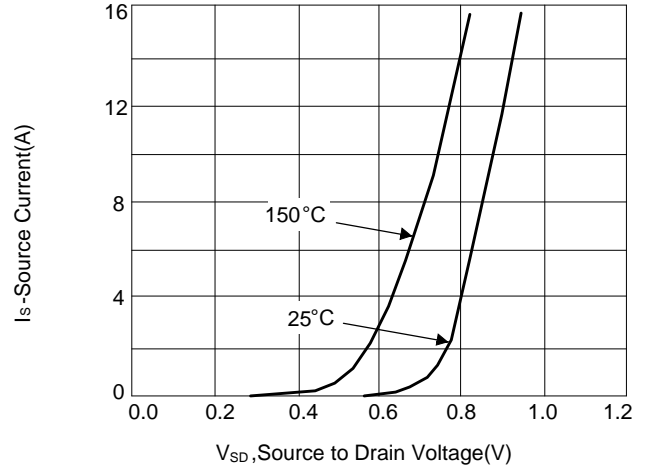

Figure 2: Body Diode Characteristics

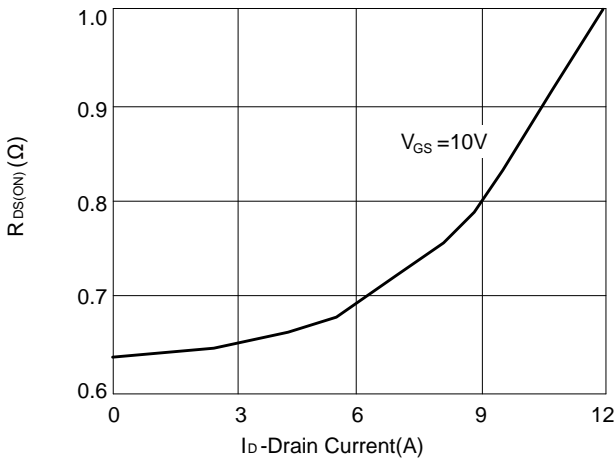

Figure 3: Drain to Source On-Resistance vs Drain Current

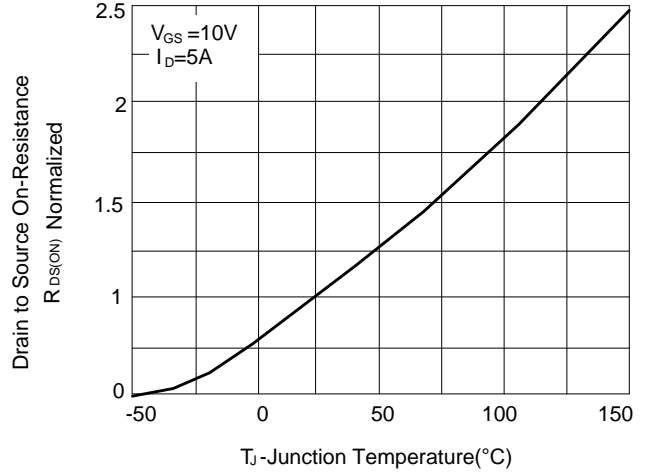

Figure 4: Drain to Source On-Resistance vs Junction Temperature

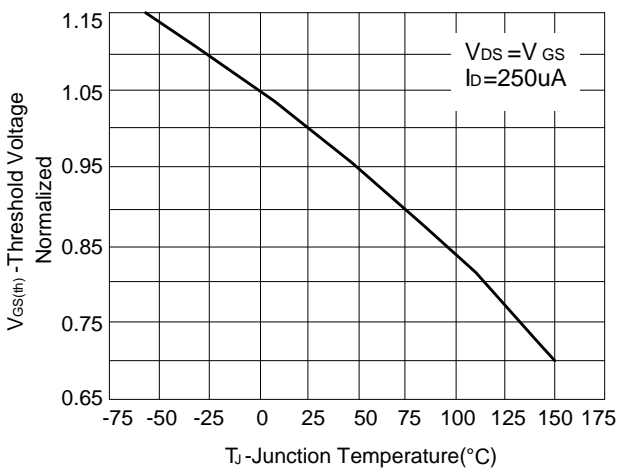

Figure 5: Threshold Voltage vs Junction Temperature

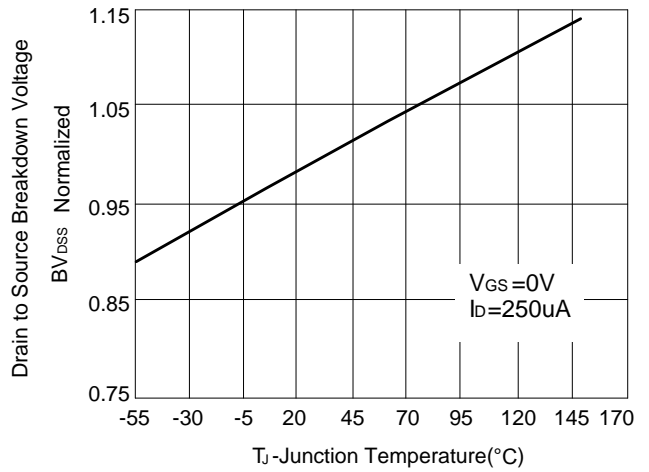

Figure 6: Breakdown Voltage vs Junction Temperature

■ TYPICAL CHARACTERISTICS(Cont.)

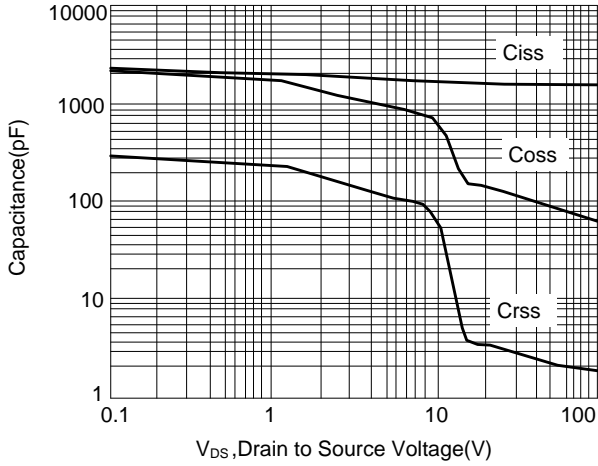

Figure 7: Capacitance vs Drain to Source Voltage

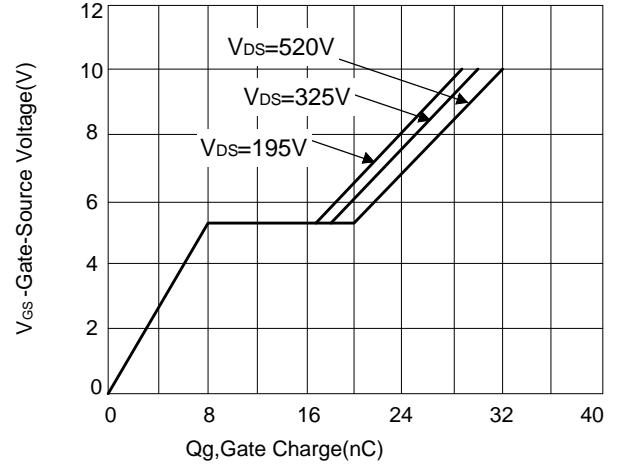

Figure 8: Gate Charge vs Gate to Source Voltage

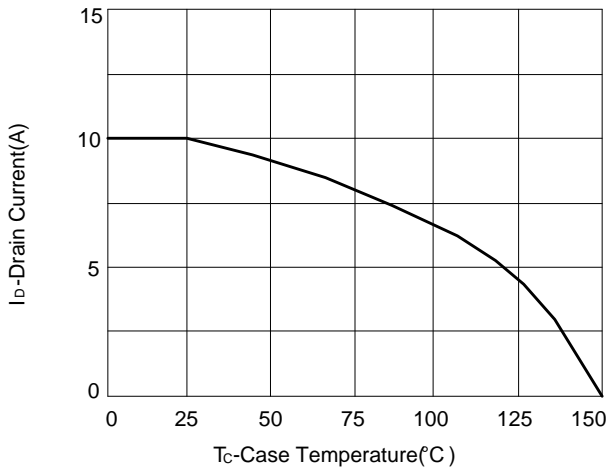

Figure 9: Continuous Drain vs Case Temperature

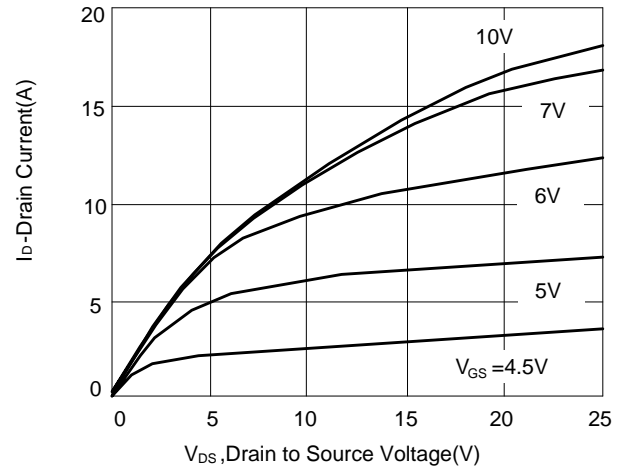

Figure 10: Output Characteristics

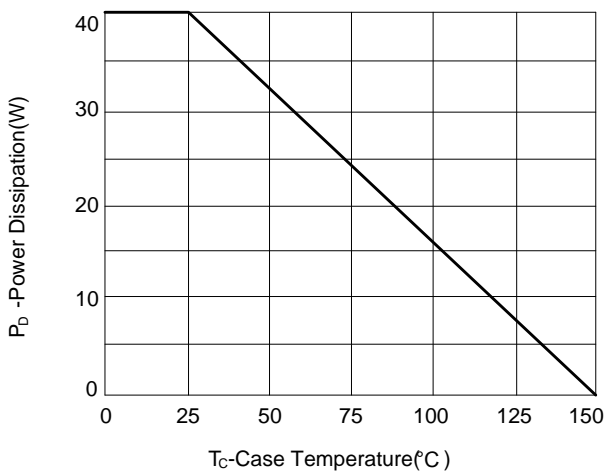

Figure 11: Power Dissipation vs Case Temperature

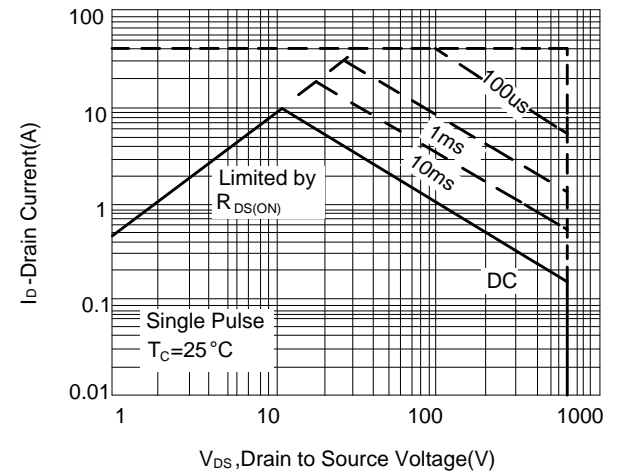

Figure 12: Safe operating Area

