

■ PRODUCT CHARACTERISTICS

$V_{DSS}$	30V
$R_{DS(ON) Typ} (@V_{GS}=10V)$	3.8m $\Omega$
$R_{DS(ON) Typ} (@V_{GS}=4.5V)$	5.2m $\Omega$
$I_D$	100A

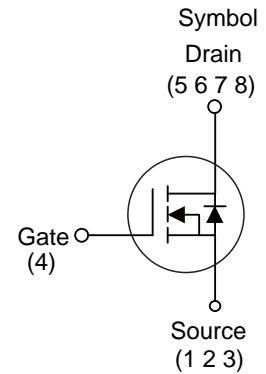

■ APPLICATIONS

- \* Electronic lamp ballasts based on half bridge
- \* Load Switching, Quick/Wireless Charge.
- \* Motor Driving

■ FEATURE

- \* Low Gate Charge
- \* Pb-Free Lead Plating

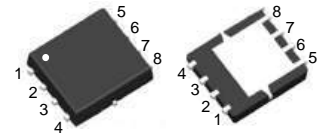

PDFN5X6

■ ORDER INFORMATION

Order Codes		Package	Packing
Halogen-Free	Halogen		
N/A	MOT3145G	PDFN5X6	5000 pieces/Reel

■ ABSOLUTE MAXIMUM RATINGS ( $T_A=25^{\circ}C$ , unless otherwise specified)

Parameter	Symbol	Ratings	Unit
Drain-Source Voltage	$V_{DSS}$	30	V
Gate-Source Voltage	$V_{GSS}$	$\pm 20$	V
Drain Current Continuous (@ $V_{GS}=10V, T_A=25^{\circ}C$ )	$I_D$	100	A
Drain Current Continuous (@ $V_{GS}=10V, T_A=100^{\circ}C$ )	$I_D$	79	A
Drain Current Pulsed	$I_{DM}$	400	A
Avalanche Energy *	$E_{AS}$	225	mJ
Power Dissipation	$P_D$	81	W
Junction Temperature	$T_J$	+150	$^{\circ}C$
Storage Temperature	$T_{STG}$	-55~ +150	$^{\circ}C$

■ THERMAL CHARACTERISTICS

Parameter	Symbol	Typ	Unit
Junction to Case	$R_{thJC}$	1.54	$^{\circ}C/W$

Note: \* EAS condition:  $T_J=25^{\circ}C, V_{DD}=24V, V_G=10V, L=0.5mH, R_g=25\Omega$

**■ ELECTRICAL CHARACTERISTICS** ( $T_C=25^{\circ}\text{C}$ , unless otherwise noted)

Parameter	Symbol	Test Conditions	Min	Typ	Max	Unit
Off characteristics						
Drain to Source Breakdown Voltage	$V_{DSS}$	$V_{GS}=0V, I_D=250\mu A$	30	-	-	V
Drain to Source Leakage Current	$I_{DSS}$	$V_{DS}=30V, V_{GS}=0V$	-	-	1	$\mu A$
Gate to Source Forward Leakage	$I_{GSS(F)}$	$V_{GS}=+20V, V_{DS}=0V$	-	-	100	nA
Gate to Source Reverse Leakage	$I_{GSS(R)}$	$V_{GS}=-20V, V_{DS}=0V$	-	-	-100	nA
On characteristics						
Drain to Source On-Resistance	$R_{DS(ON)}$	$V_{GS}=10V, I_D=20A$	-	3.8	4.5	m $\Omega$
		$V_{GS}=4.5V, I_D=20A$	-	5.2	6.5	m $\Omega$
Gate Threshold Voltage	$V_{GS(TH)}$	$V_{DS}=V_{GS}, I_D=250\mu A$	1	1.6	2.5	V
Dynamic characteristics						
Gate capacitance	$R_g$	$V_{GS}=0V, V_{DS}=0V, f=1.0\text{MHz}$	-	2.8	-	$\Omega$
Forward Transconductance	$g_{fs}$	$V_{DS}=10V, I_D=3A$	-	12	-	S
Input Capacitance	$C_{iss}$	$V_{DS}=20V, V_{GS}=0V$ $f=1.0\text{MHz}$	-	2500	-	pF
Output Capacitance	$C_{oss}$		-	298	-	pF
Reverse Transfer Capacitance	$C_{rss}$		-	232	-	pF
Resistive Switching Characteristics						
Turn-on Delay Time	$t_{d(ON)}$	$V_{GS}=10V, V_{DS}=15V,$ $I_D=20A, R_G=6\Omega$	-	6	-	ns
Rise Time	$t_r$		-	9	-	ns
Turn-off Delay Time	$t_{d(OFF)}$		-	32	-	ns
Fall Time	$t_f$		-	8	-	ns
Total Gate Charge	$Q_g$	$I_D=20A, V_{DS}=15V$ $V_{GS}=10V$	-	31.3	-	nC
Gate to Source Charge	$Q_{gs}$		-	3.7	-	nC
Gate to Drain("Miller") Charge	$Q_{gd}$		-	8	-	nC
Source-Drain Diode Characteristics						
Continuous Source Current(Body Diode)	$I_S$		-	-	100	A
Maximum Pulsed Current(Body Diode)	$I_{SM}$		-	-	400	A
Diode Forward Voltage	$V_{SD}$	$I_{SD}=1A, V_{GS}=0V$	-	0.72	1.2	V
Reverse Recovery Time	$t_{rr}$	$I_{SD}=20A, T_J=25^{\circ}\text{C}$ $di/dt=100A/\mu s$	-	45	-	ns
Reverse Recovery Charge	$Q_{rr}$		-	22	-	nC

■ TYPICAL CHARACTERISTICS

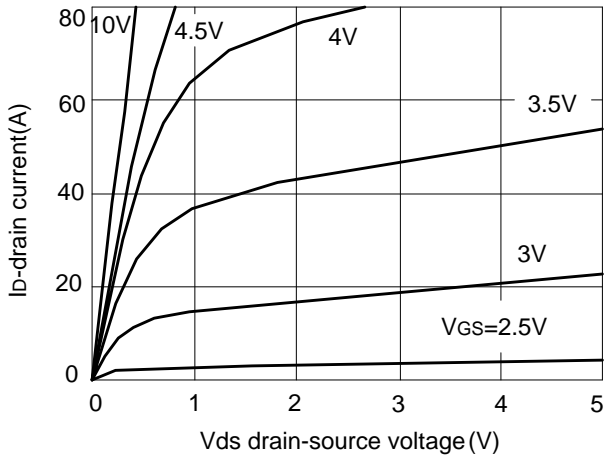

Figure.1 Output characteristics

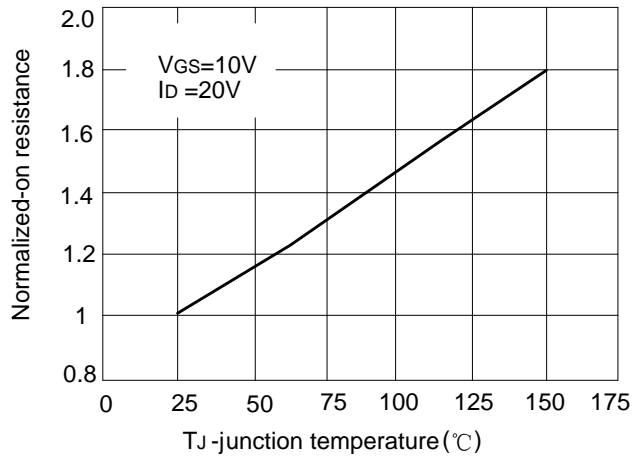

Figure.2  $R_{dson}$ -junction temperature

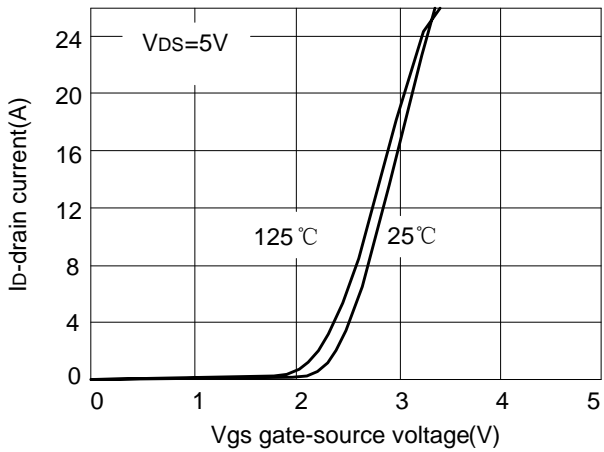

Figure.3 Transfer characteristics

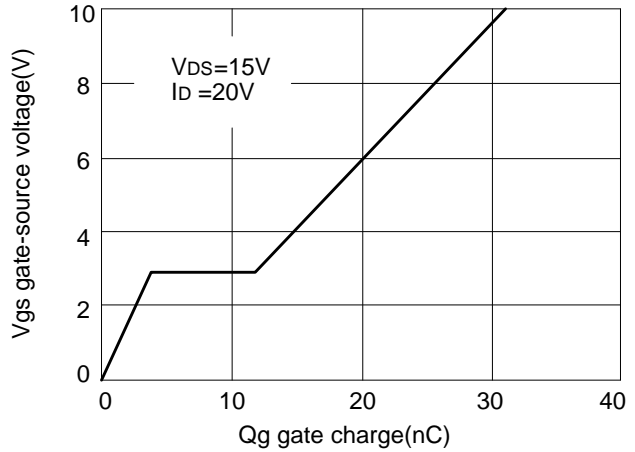

Figure.4 Gate charge characteristics

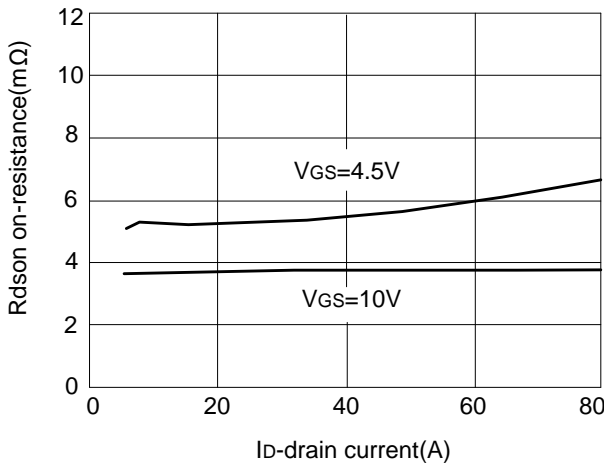

Figure.5  $R_{dson}$ -drain current

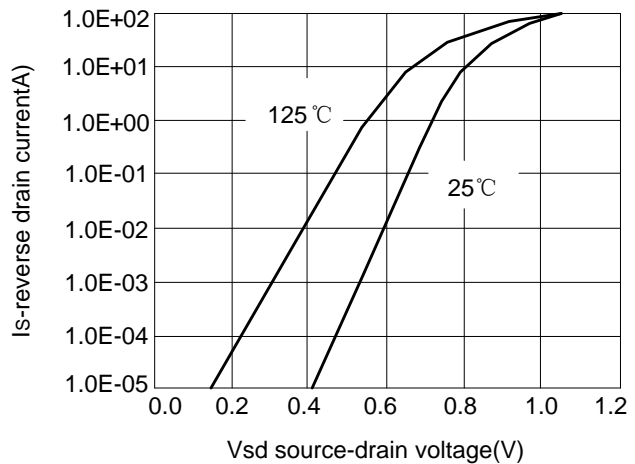

Figure.6 Source-drain diode forward

■ TYPICAL CHARACTERISTICS(Cont.)

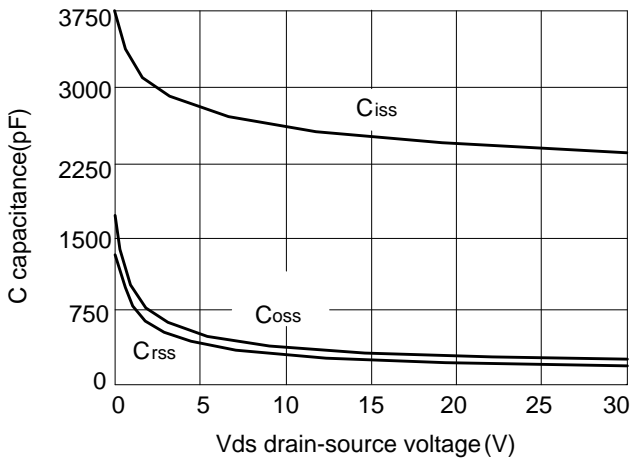

Figure.7 Capacitance vs vds

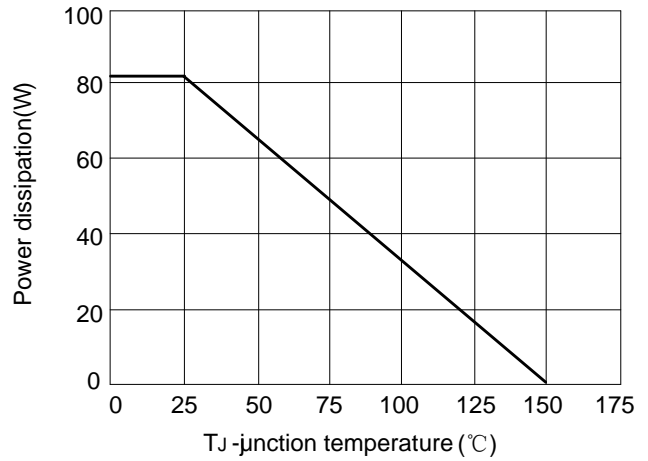

Figure.8 Power de-rating

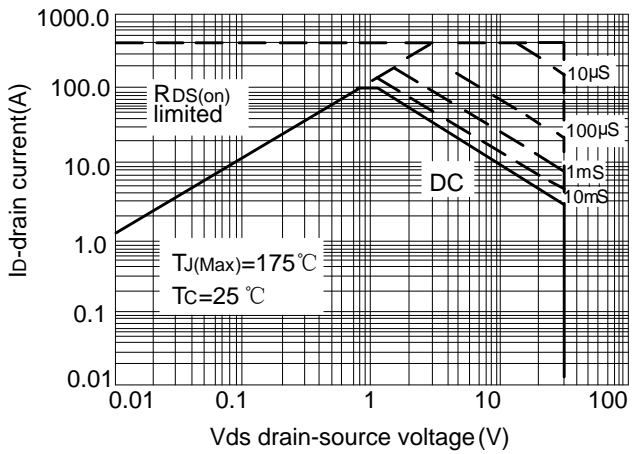

Figure.9 Safe operation area

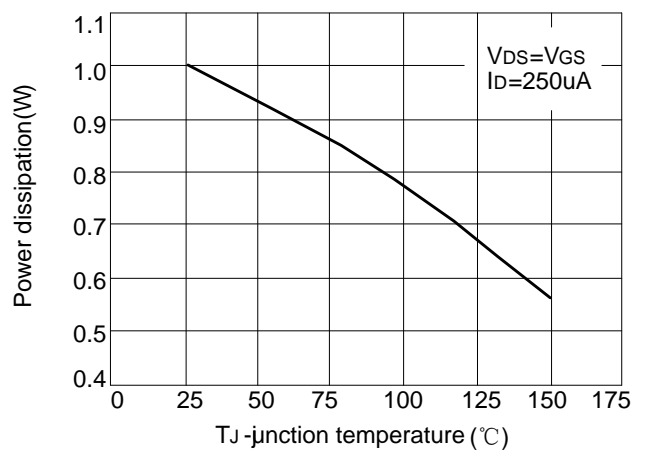
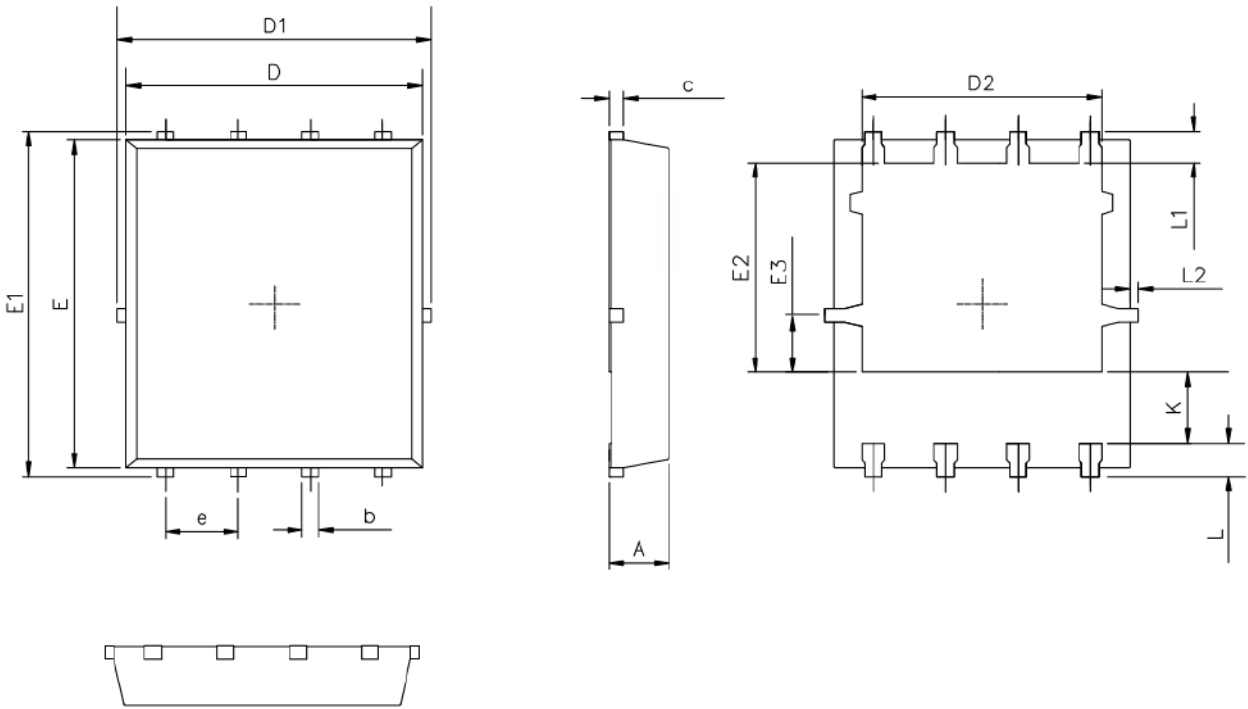
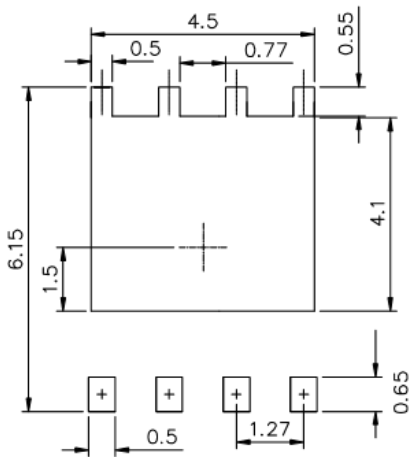

Figure.10 Power de-rating

■ PDFN5X6 PACKAGE OUTLINE DIMENSIONS



RECOMMENDED LAND PATTERN



UNIT:mm

	MIN	NOM	MAX
A	0.90	1.00	1.10
b	0.25	0.35	0.50
c	0.10	0.20	0.30
D	4.80	5.00	5.30
D1	4.90	5.10	5.50
D2	3.92	4.02	4.20
E	5.65	5.75	5.85
E1	5.90	6.05	6.20
E2	3.325	3.525	3.775
E3	0.80	0.90	1.00
e		1.27	
L	0.40	0.55	0.70
L1		0.65	
L2	0.00		0.15
K	1.00	1.30	1.50